

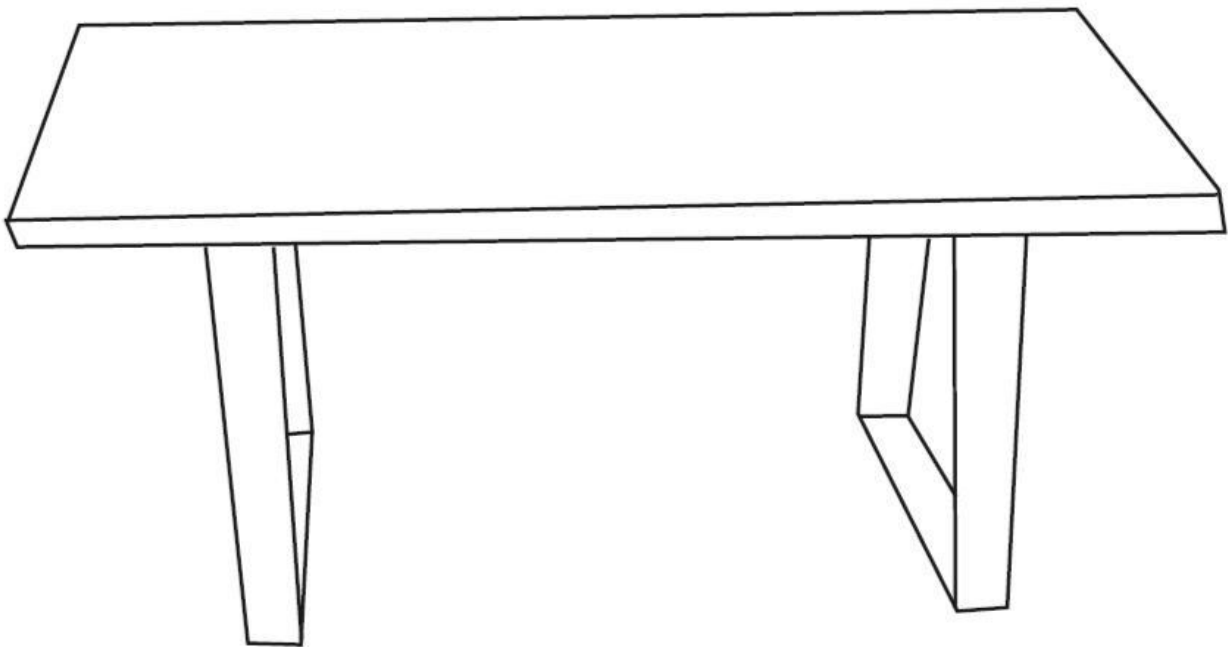

CC0401/CC1078/CC1079

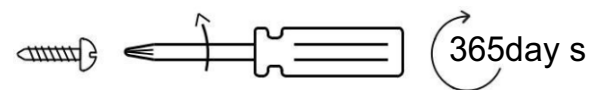

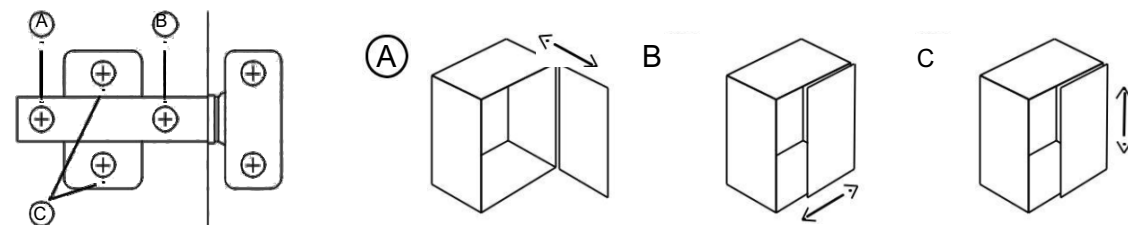

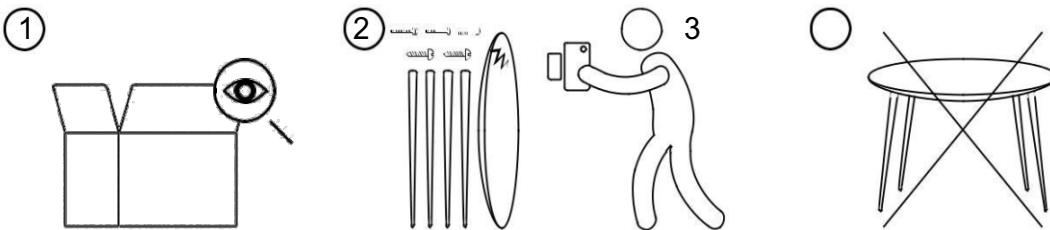
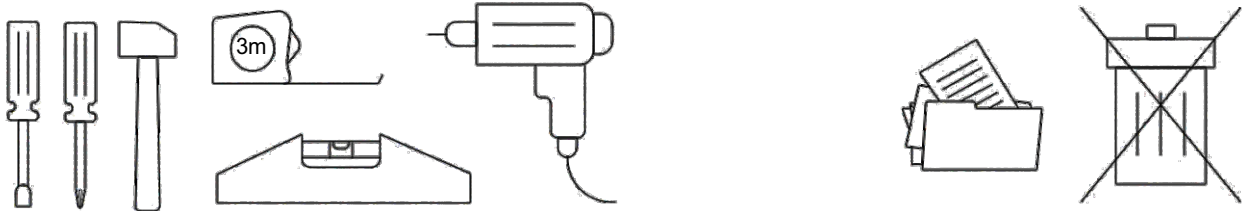
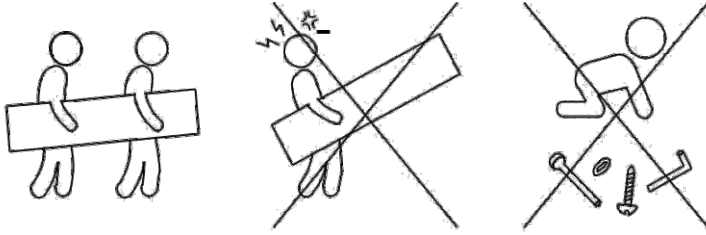

15 min

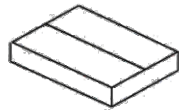

x1



x1



Ax1



Bx2



Cx8



Dx8



Ex1

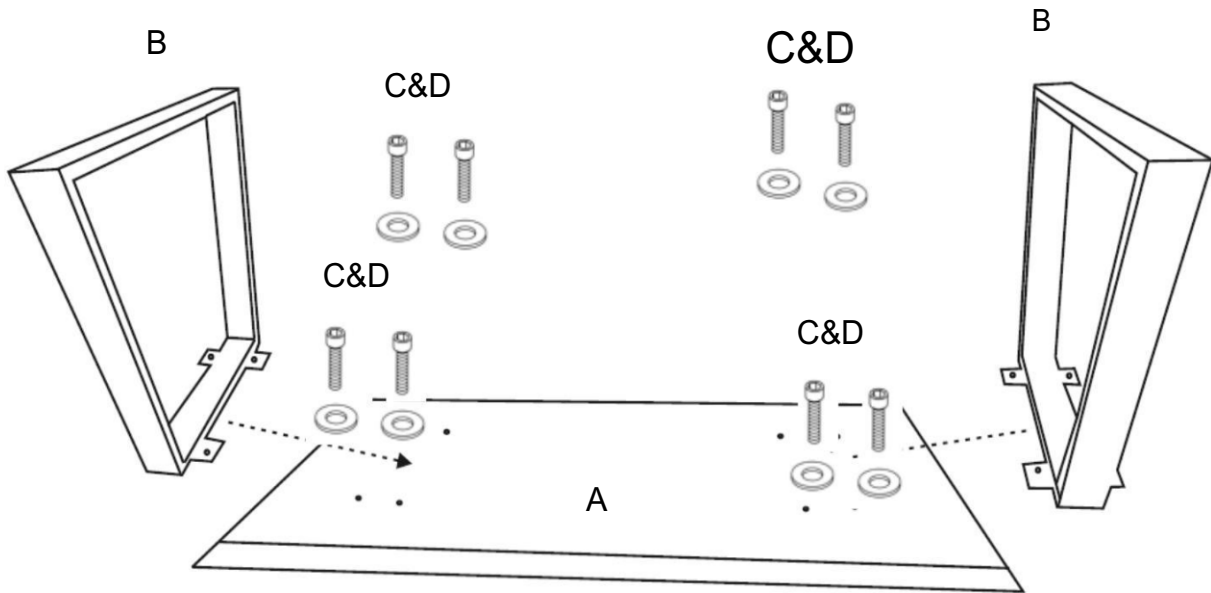



1

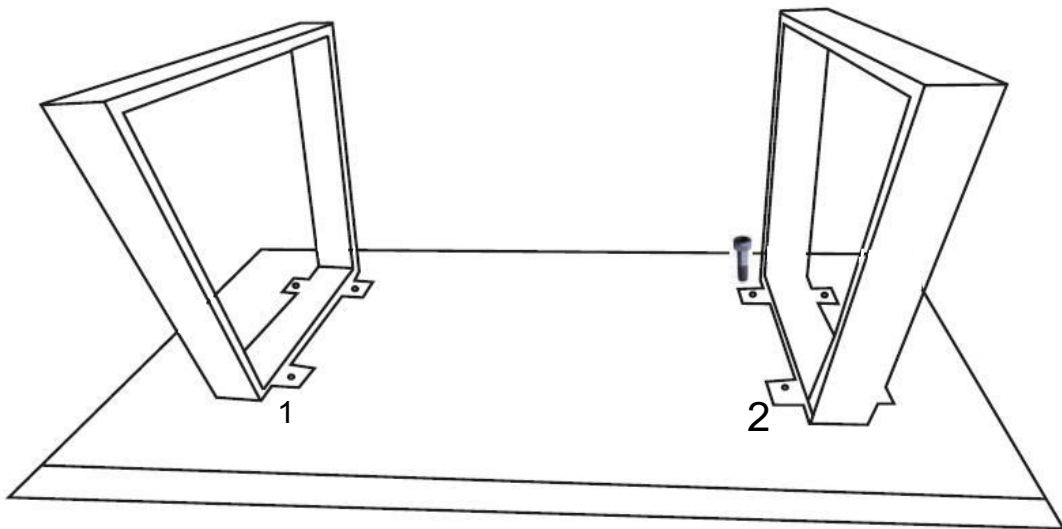



Fabricado en / Made in / Fabriqué à / Fabbriato in: IN

Composición de materiales / Material composition / Composition des matériaux / Composizione dei materiali:

Top material	Acacia wood (Acacia sensu lato)
Top finishing	Matt varnish
Legs material	Steel
Legs finishing	Powder coated

Condiciones de uso y mantenimiento / Use and maintenance conditions / Conditions d'utilisation et maintenance / Condizioni d'uso e mantenimento:

Use (domestic/office)	Domestic
Appliance (inner/outer)	Inner
Specific use and care instructions	Clean with a damp cloth and dry immediately
General warnings	Do not put near direct sources of heat. Do not put in direct solar light. Do not use abrasive products like acetones, bleaches, solvents, etc.



JULIÀ GRUP Furniture Solutions S.L. Garantía / Guarantee / Garantie / Garanzia

ES

En virtud de lo que dispone la Ley General por la Defensa de los Consumidores y Usuarios –Ley 3/2014 aprobada por el RDL 1/2007–, la Directiva europea 2011/83/EU del Parlamento Europeo y del Consejo en materia de la Protección de los Consumidores y Usuarios, los productos comercializados por Julià Grup SL tienen una garantía de 2 años sobre defectos de fabricación y vicios ocultos.

Este producto está creado para un uso estrictamente doméstico. Julià Grup declina toda responsabilidad de las posibles reclamaciones producidas por un uso diferente al que este producto ha sido creado.

Quedan excluidos de esta garantía los productos que presenten daños causados por un montaje no conforme a las instrucciones de montaje, un uso inadecuado o incorrecto del producto, desgaste no prematuro o envejecimiento del producto, variaciones naturales de color/textura propias de un uso normal y/o mantenimiento no conforme a las especificaciones del fabricante. Compruebe la mercancía antes de firmar el albarán. No se admiten reclamaciones por motivos de transporte que no hayan quedado registradas en el albarán o que no nos las hayan comunicado en las 24 horas siguientes a su recepción.

Nuestra garantía cubre la reparación y sustitución de las partes afectadas en caso de defectos de fabricación. Para la validez de la garantía será condición necesaria e indispensable facilitar los datos de compra, referencia del producto, el defecto y la parte afectada. Julià Grup se reserva el derecho de no hacer efectiva la garantía si no se facilita la información necesaria, o generar un cargo por gastos de transporte y reparación del producto, cuando el problema no sea derivado por un defecto de fabricación cubierto por esta garantía.

EN

In accordance with the General Law for the Defense of Consumers and Users –Act 3/2014 approved by RDL 1/2007–, which provides Regulations on Guarantee in the sale of Consumer Goods, the Directive 2011/83/EU of the European Parliament and the Council on Consumer Rights and the rules laid out in the General Law for the Defense of Consumer Rights, the products distributed by Julià Grup SL have a warranty of 2 years for production defects and hidden defects.

This product is created strictly for domestic use only. Julià Grup declines all responsibility for potential claims caused by any use different from the one for which the product was created.

Exempt from this warranty are products with defects caused by poor assembling, inappropriate use, wearing out or old age of the product, changes in colors and materials in line with natural use of the product and/or maintenance different from the one prescribed by the producer.

Check the goods before signing the transport document for good receipt. We do not accept claims for goods which have been signed off as received properly and which are not communicated to Julià Grup within 24 hours upon receipt.

Our guarantee covers repair and substitution of parts defected in case manufacturing faults. For a proper handling of any claim it is absolutely necessary to identify the product, a detailed description of the part of the product where a problem has occurred, the number of the invoice for this product, a picture of the defect, etc. Julià Grup has the right to invalidate the guarantee if required information is not available or to charge repairs or transport (or both) in the case of the fault not deriving from the manufacturing of the product.

FR

Conformément à la Loi Générale pour la Défense des Consommateurs et des Usagers –Loi 3/2014 approuvée par RDL 1/2007– qui fournit la réglementation sur les Garanties dans la vente de Biens de Consommation, et à la directive 2011/83/UE du Parlement Européen et du Conseil, les produits commercialisés par Julià Grup SL ont une garantie de 2 ans sur les défauts de fabrication et les vices cachés.

Ce produit est destiné à un usage strictement domestique. Julià Grup décline toute responsabilité des possibles réclamations résultants d'une utilisation autre que celle pour la quelle le produit a été créé.

Sont exclus de cette garantie de produits affectés par les dégâts causés par un montage non conforme aux instructions d'assemblage, une mauvaise utilisation du produit, usure ou vieillissement du produit ou variations naturelles de couleur/texture typique des conditions normales d'utilisation, l'utilisation et/ou maintenance ne pas conformes aux spécifications du fabricant.

Vérifiez la marchandise avant de signer l'ordre de remise. Les réclamations dues au transport pas indiquées dans l'ordre de remise ou pas communiquées pendant les 24 heures suivantes à la réception ne seront pas acceptées.

Notre garantie couvre la réparation ou le remplacement des parties affectées en cas de défauts de fabrication. Il sera essentiel d'indiquer le produit concerné, une description détaillée du défaut en indiquant clairement la zone concernée, le numéro du bordereau de livraison ou la facture du produit, et une photographie de la partie affectée. Julià Grup se réserve le droit de ne pas faire prendre effet cette garantie si les informations ne sont pas bien fournies ou transmettre une charge des frais de transport et de réparation du produit lorsque le problème ne provient pas d'un défaut de fabrication.

IT

In conformità con la Legge Generale per la Difesa dei Consumatori e degli Utenti –Legge 3/2014 del RDL 1/2007–, la direttiva 2011/83 / UE del Parlamento Europeo e del Consiglio sui Diritti dei Consumatori per la vendita di beni di Consumo e in accordo con la normativa vigente espressa dalla Legge Generale per la Difesa dei Consumatori, i prodotti commercializzati da Julià Grup SL hanno una garanzia di 2 anni che copre i difetti di fabbricazione e eventuali difetti occulti.

Questo prodotto è creato per un uso estrictamente domestico. Julià Grup declina tutta la responsabilità sulle possibili reclamo derivati da un uso diverso per cui è stato creato.

Sono esclusi dalla garanzia i prodotti che presentano danni causati da un montaggio non conforme alle istruzioni di montaggio, prodotti danneggiati per un uso incorretto, prodotti utilizzati quindi sottoposti a variazioni naturali di colore o finiture generate da un uso normale e prodotti ai quali si sottoponga un mantenimento non conforme a le indicazioni del fabbricante.

Controllare la merce prima di firmare la consegna d'ordine. Non si accetteranno reclami per motivi di trasporto che non siano stati indicati nell'ordine di consegna o che non ci siano stati comunicati durante le prossime 24 ore dalla ricezione della merce.

Il nostro garanzia copre la riparazione e la sostituzione di parti interessate in caso di difetti di fabbricazione. È imprescindibile indicare il prodotto interessato, fare una descrizione dettagliata indicando chiaramente la parte difettosa, indicare il numero della bolla o della fattura referente al prodotto in questione e documentare con una fotografia la parte danneggiata. Julià Grup si riserva il diritto di non richiedere la garanzia, se non fornito le informazioni necessarie, o generare un onere per i costi di trasporto e di riparazione di prodotti in cui il problema non deriva da un difetto di fabbricazione coperti da questa garanzia.

JULIÀ GRUP Furniture Solutions S.L.

B-17616277

Pol. Ind. Bosc d'en Cuca

C / Tallers, 14

17410 Sils SPAIN

info@juliagrup.com